

# INTERIOR SPECIALTIES SHOWER DOOR ORDERING WORKSHEET

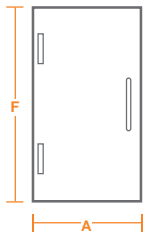

1. Single Door

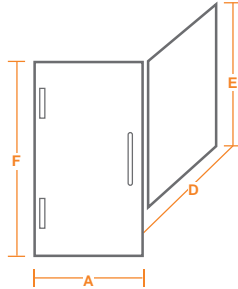

2. Single Door w/90° Half Panel Return

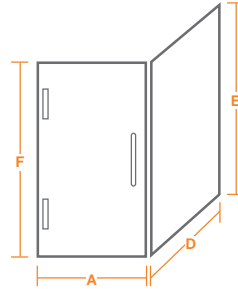

3. Single Door w/90° Full Panel Return

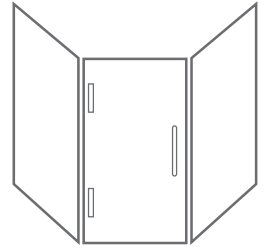

4. Neo Angle (Estimate Only)

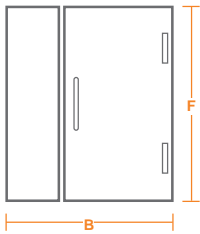

5. Door w/Inline Pane

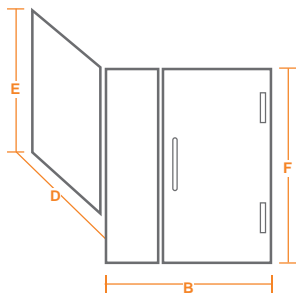

6. Door w/Inline Panel 90° Half Panel Return

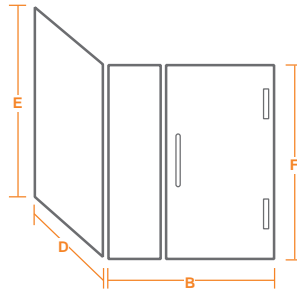

7. Door w/Inline Panel 90° Full Panel Return

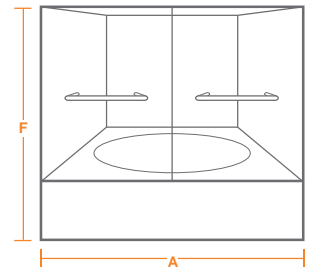

8. Recessed Tub 90°

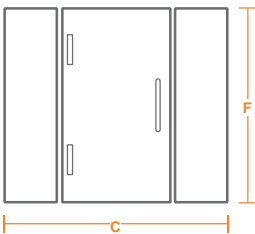

9. Door w/ 2 Inline Panels

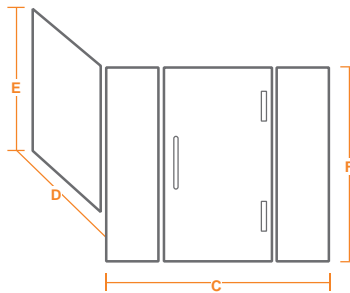

10. Door w/2 Inline Panels, 90° Half Panel Return

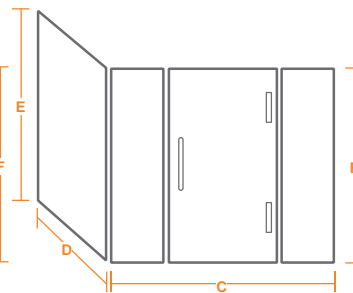

11. Door w/2 Inline Panels, 90° Full Panel Return

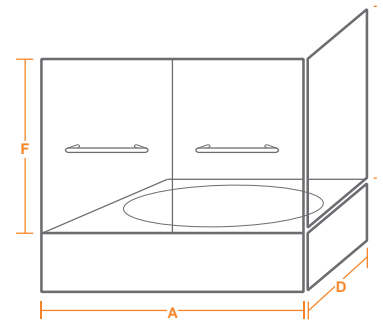

12. Partially Recessed Tub 90 Double Sliders

A = Door Width: \_\_\_\_\_ D = 90° Panel Depth: \_\_\_\_\_ Configuration Number: \_\_\_\_\_

B = Door Width w/inline panel: \_\_\_\_\_ E = 90° Panel Height: \_\_\_\_\_ Glass Type: Clear / Other

C = Door Width w/2 inline panels: \_\_\_\_\_ F = Door Height: \_\_\_\_\_

Hardware Finish:  
 Chrome / Brush Nickel / Oil Rub Bronze / Other